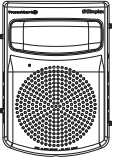
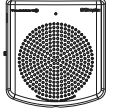

UL listed TrueAlert ES indoor product identification reference:

Type	Cover colors	Models			Operation	
Wall Mount Speaker/ Visible (S/V) 	-Red -White	Components: 49SV-APPLW 49HFV-APPLW 49SV-APPLW-BA 49HFV-APPLW-BA	Covers: 49SVC-WRFEU 49SVC-WRFIRE 49SVC-WRS 49SVC-WWALT 49SVC-WWBA 49SVC-WWS 49SVC-WWFIRE	49SVC-WRBF 49SVC-WRBC 49SVC-WRBA 49SVC-WRALT 49SVC-WWBC 49SVC-WWBF 49SVC-WWFEU	Backplates: 49MP-SVWR 49MP-SVWW	These appliances provide a visible (VO) or audible/visible (A/V) warning of an alarm condition when activated from the control panel of a compatible UL/ULC Listed, Simplex Fire Alarm System. Consult Simplex Fire Alarm panel documentation for compatibility information. The speakers can be turned ON/OFF individually under compatible panel control.
Wall Mount Speaker Only (SO) 	-Red -White	Components: 49SO-APPLW 49HF-APPLW 49SO-APPLW-BA 49HF-APPLW-BA	Covers: 49SOC-WRFEU 49SOC-WRBF 49SOC-WRBC 49SOC-WRBA 49SOC-WWS 49SOC-WWFIRE 49SOC-WRBLANK 49SOC-WRFIRE	49SOC-WRS 49SOC-WWBA 49SOC-WWBC 49SOC-WWBF 49SOC-WWFEU 49SOC-WWBLANK 49SOC-WWALT 49SOC-WRALT	Backplates: 49MP-SOWR 49MP-SOWW	

Note: For information about TrueAlert ES appliance testing consult *TrueAlert ES Addressable Appliances Troubleshooting (579-1049)*.

Mounting instructions:

Kit contents:	Appliance x1.
Not included:	Order a Backplate separately for each appliance, with 8-32 1 inch mounting screws x2, and 6-32 1 inch mounting screws x2. Order a cover separately for each appliance. Electrical box: 4 inch square, 2-1/8 inch minimum depth required.

1. Select the mounting location and install the electrical box using screws suitable for the mounting surface.
2. Bring the building wiring through the rectangular opening in the backplate.
3. Connect the building wires to the backplate. See the wiring section on page 2.
4. Secure the backplate to the electrical box using the provided hardware. Install the backplate so that the contacts are above the opening for the wiring.
5. Set the appliance settings. See the settings section on page 3.
6. Attach the cover to the appliance.
7. Attach the assembled appliance to the backplate.

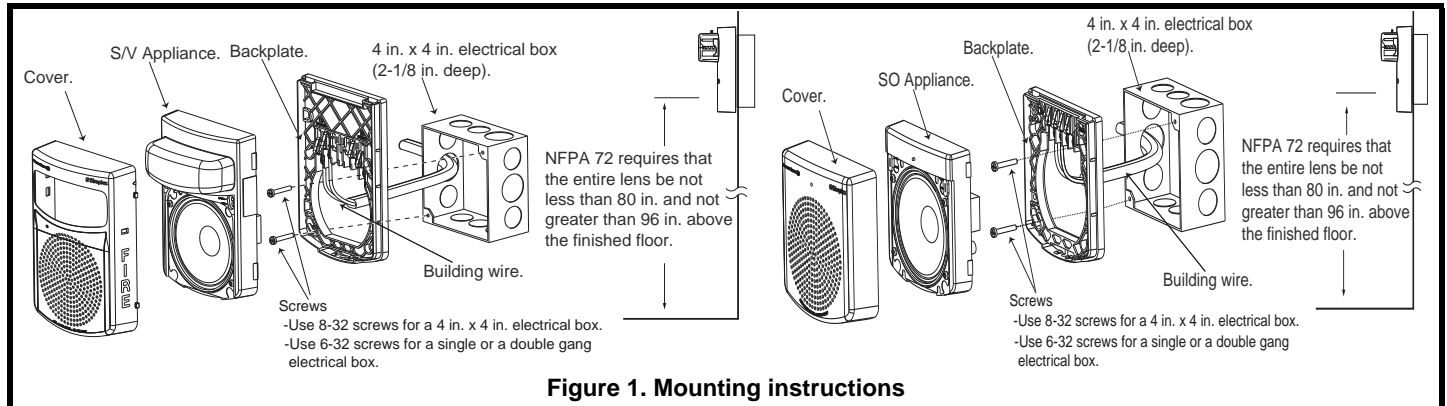





Figure 1. Mounting instructions

 **IMPORTANT.** When the notification appliance emits light or sound, it indicates the possibility of an emergency situation that requires the immediate attention of all occupants.

 **LOCATION REFERENCE.** The location and quantity of appliances required must conform to the applicable local standards and guidelines, the National Fire Alarm and Signaling Code (NFPA 72), ULC Standard CAN/ULC-S524: Installation of Fire Alarm Systems, the appropriate model building codes, and so on, and specific requirements of the Local Authority Having Jurisdiction (AHJ). These Notification Appliances are not intended for installation within hazardous locations as defined by the National Electrical Code (NEC) or NFPA.

 **SAFETY.** Always install, maintain, and test Notification Appliances within their specifications. Failure to follow all safety precautions and instructions may result in loss of life and property due to non-functioning Notification Appliances. Some Notification Appliances use high voltage. To avoid electrical hazards and avoid damage to appliances, make sure that the electrical power for the Notification Appliance Circuit is disconnected at the control panel before installing, repairing, or internally adjusting any Notification Appliances. Even with electrical power removed, some Notification Appliances, such as visible strobes, store a high voltage charge. The high voltage can cause injury resulting in death from electrical shock. **DO NOT TOUCH EXPOSED CIRCUITRY.**

Wiring instructions:



WARNING: Make sure that all power is disconnected before starting the installation.

1. At the electrical box, connect the building wiring to the CKT + and CKT - terminals on the backplate.
2. To ensure proper continuity, use a torque wrench to tighten the terminal block screws to 12-15 inch-pounds.
3. Ensure that the correct polarity is maintained for each strobe unit.
4. Signal Line Circuit (SLC) wiring must be twisted pair (TWP). CKT Terminals accept 2 Wires: 12-18 American wire gauge (AWG) TWP.

IMPORTANT: Do not bring the conduit through the rear of the electrical box. Strip the lead insulation to 7/16 inch maximum.

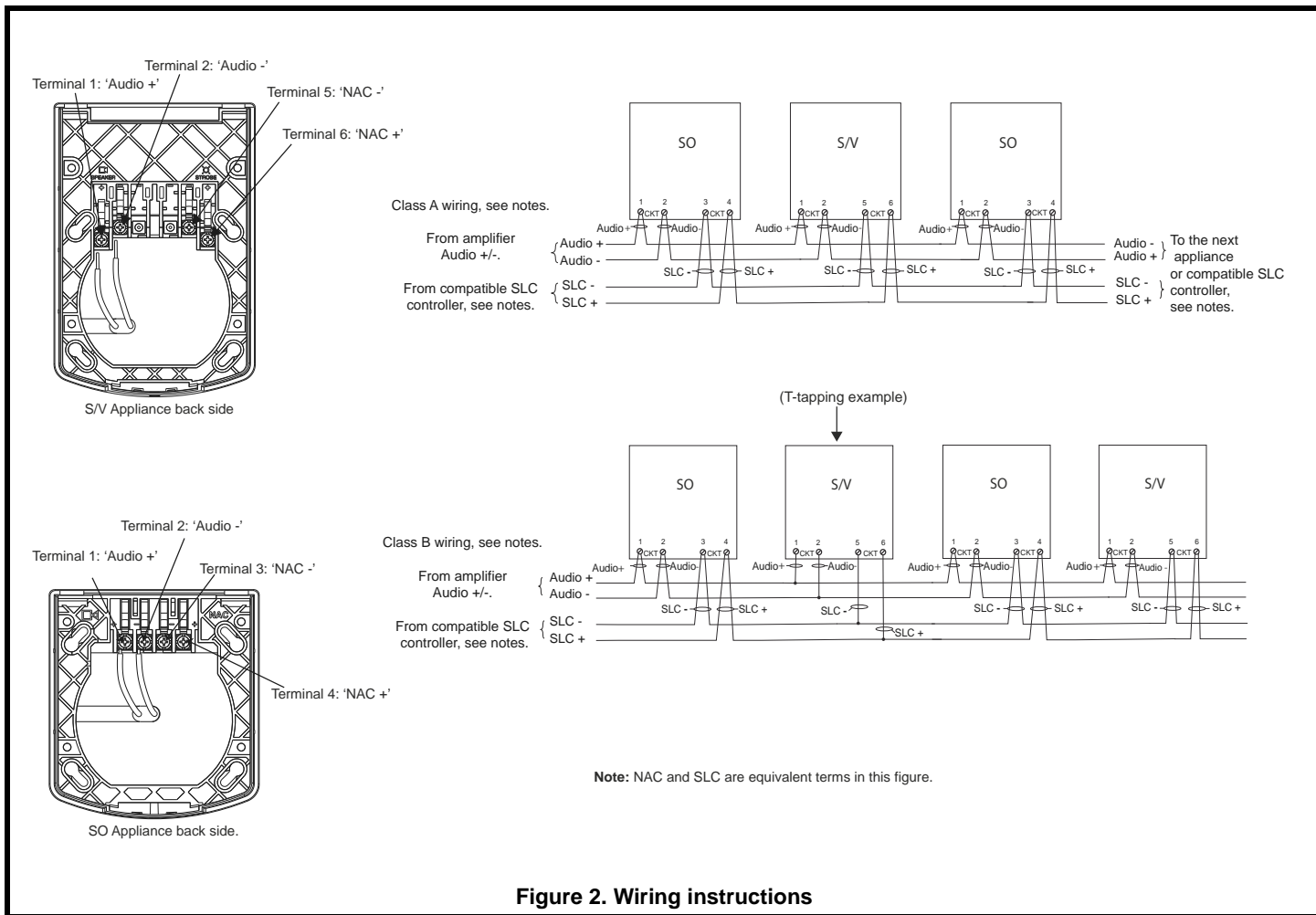

Figure 2. Wiring instructions

Wiring notes:

1. Assign a maximum of 127 active appliances to a circuit. Assign a maximum of 63 active strobe appliances to a powered circuit. The maximum wire resistance between appliances is 26 ohms. Refer to the Field Wiring Diagrams of the driving compatible fire alarm control panel for further instructions.
2. Notification appliances are rated using an individual module label.
3. Maintain the correct polarity on the terminal connections.
4. Terminals 1 through 6 each accommodate two wires, one wire going in and one wire going out to the next appliance.
5. These appliances are rated to the operating voltage limits of 23-30 VDC. The appliance can fail to operate as intended, and can cause permanent damage to this equipment if it operates outside of these limits.
6. Only operate the TrueAlert IDNAC S/V and SO using a compatible power supply and amplifier.
7. T-tapping is not permitted for Class A wiring.
8. TrueAlert SLC wiring connections are supervised and power-limited.

Setting the address DIP switch

Each addressable TrueAlert IDNAC notification appliance has a unique address that is set using an eight-position DIP switch (ADDR1). Up to 127 unique addresses can be assigned to an SLC, however, the total appliance loading available may be less due to appliance current requirements.

To Set the address:

1. Unclip the appliance from the backplate by inserting a number 2 Phillips screwdriver, or a similar sized object into the opening at the bottom of the cover. See Figure 3.
2. Use a small screwdriver or pen to set the switches.
3. Record the set address.
4. DIP switch position 8 determines whether this appliance is viewed by the system as an 'ALARM' (OFF) or 'ALERT' (ON) type of appliance. Confirm the setting for the appliance at this address with the FACP system configuration documentation.
5. DIP position 9 selects white flash color (standard - OFF), or tinted strobe power level (ON) for use with add-on domes.

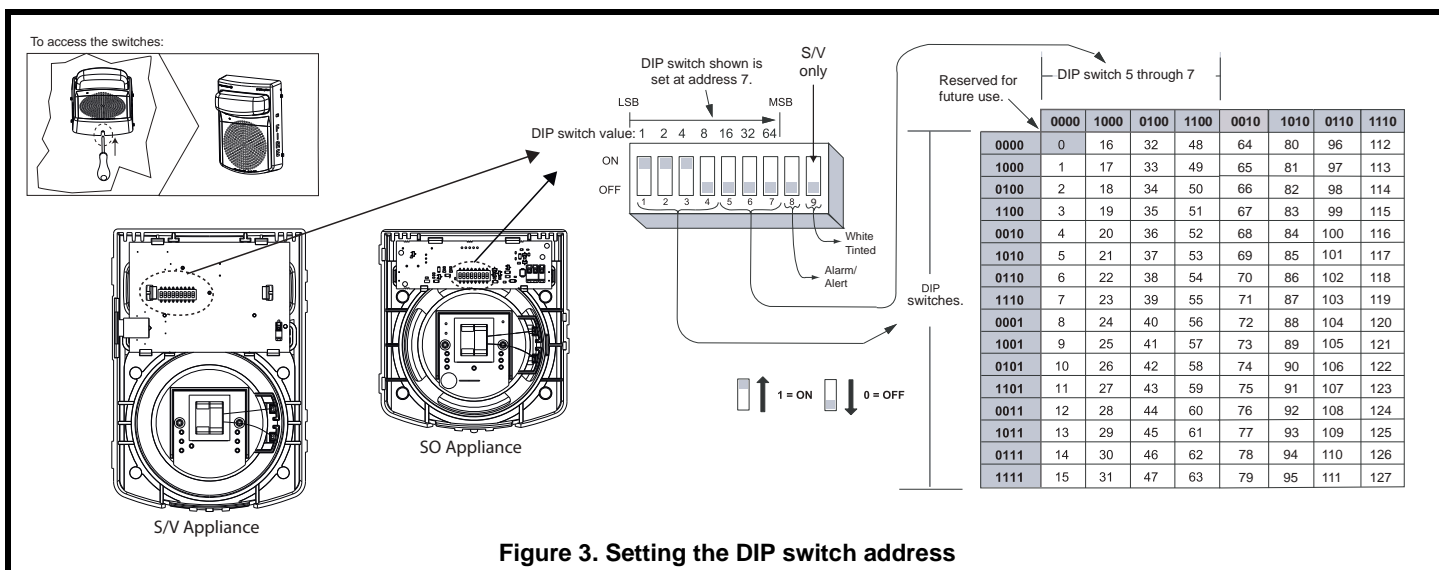

Figure 3. Setting the DIP switch address

Setting the strobe candela setting

1. Jumpers are factory set as FACP. Leave the appliance at this setting if the candela setting is to be programmed from a 4100ES FACP. The candela setting is visible through the slot on the side of the appliance.
2. If manual selection is required, pull up the candela flag and position the pins to select the correct candela setting: 15, 30, 75, 110, 135, 185 candela, or FACP.
3. The candela ratings vary when colored lenses are used. Consult the *TrueAlert ES WM S/V Colored Lens* document (579-1192) for the specific candela ratings.
4. When the appliance is mounted, the candela rating is visible through the slot on the side of the appliance.

Note: To avoid a programming mismatch trouble, an authorized service personnel must program one of the 6 candela outputs for each appliance. To set the candela through the Programmer, set it to FACP. For additional information refer to the *4100ES Programmer's Manual* (574-849).

Audio circuit configuration, S/V and SO

Move the wire harness position to the correct terminal post for audio circuit voltage and power tap selection. See Figure 4 and the speaker table on the next page.

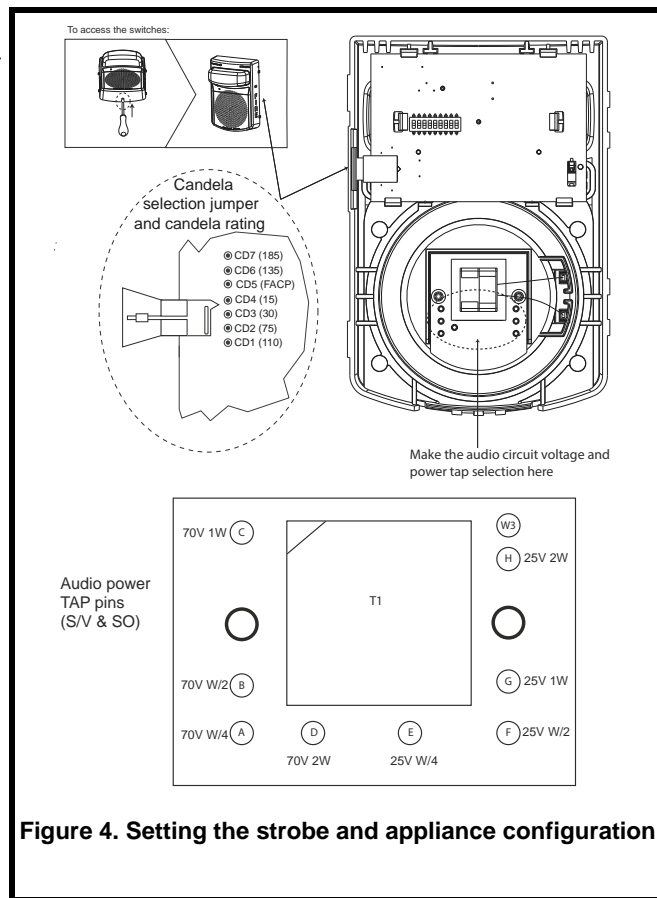

Figure 4. Setting the strobe and appliance configuration

Appliance specifications

Environmental specifications:			
Rated DC Control/Strobe Voltage Range	SPECIAL APPLICATION 23-30 VDC		
Temperature Range	32 °F to 120° F (0 °C to 49 °C)		
Humidity Range	10 % to 93 %, non-condensing at 104 °F (40 °C)		
Connections	Terminal for 18 AWG to 12 AWG (0.82 mm ² to 3.31 mm ²)		
CAUTION:			
• The appliances are available in Red and White. Do not paint or otherwise alter the factory finishes in any way.			
Maximum RMS operating current			
Candela selection†	Appliance type	UL1971/ULCS526 Clear/White	UL1638/ULCS526 Colored Lens
		23V*	23V*
15 cd	S/V	47 mA	54 mA
30 cd	S/V	57 mA	78 mA
75 cd	S/V	100 mA	128 mA
110 cd	S/V	132 mA	184 mA
135 cd	S/V	160 mA	211 mA
185 cd	S/V	208 mA	-NA-
Speaker Only	SO	9 mA	-NA-
* For connection to IIDNAC SLCs			
† The use of optional colored lenses can affect the device's candela output. To find the candela output for each color consult the <i>TrueAlert ES WM S/V Colored Lens</i> document (579-1192).			

Percent of rated light output at any candela setting (room temperature)					
Vertical dispersion			Horizontal dispersion		
Y-Plane Angle	UL Req Output	Typical Output	X-Plane Angle	UL Req Output	Typical Output
0	100 %	194 %	0	100 %	194 %
5	90 %	192 %	±5	90 %	203 %
10	90 %	132 %	±10	90 %	168 %
15	90 %	129 %	±15	90 %	155 %
20	90 %	145 %	±20	90 %	166 %
25	90 %	150 %	±25	90 %	169 %
30	90 %	112 %	±30	75 %	164 %
35	65 %	124 %	±35	75 %	151 %
40	46 %	114 %	±40	75 %	145 %
45	34 %	90 %	±45	75 %	121 %
50	27 %	91 %	±50	55 %	97 %
55	22 %	78 %	±55	45 %	83 %
60	18 %	72 %	±60	40 %	79 %
65	16 %	68 %	±65	35 %	70 %
70	15 %	75 %	±70	35 %	59 %
75	13 %	74 %	±75	30 %	50 %
80	12 %	68 %	±80	30 %	51 %
85	12 %	63 %	±85	25 %	45 %
90	12 %	45 %	±90	25 %	41 %

Wall speaker specifications		
Input Voltage	25 VRMS or 70.7 VRMS - Speakers are for connection to compatible fire alarm audio circuits.	
Power Taps via Jumper J1	1/4 W, 1/2 W, 1 W and 2 W	
Frequency Response	Fire Alarm	400 Hz to 4000 Hz [SV/SO]; 200 Hz to 10000 Hz [HFV/HF]
	General Signaling	125 Hz to 12 kHz

TrueAlert Addressable Wall Mount S/V and SO Units - speaker jumper setting (25 V or 70 V audio)						
Voltage	Jumper J1 to Tap	Tap setting in Watts	UL1480 at 10 ft		ULC-S541 at 3 m	
			HiSPL (SV/SO) Models	HiFi (HFV/HF) Models	HiSPL (SV/SO) Models	HiFi (HFV/HF) Models
Speaker Only	A/E	1/4	79	76	80	76
	B/F	1/2	83	80	84	79
	C/G	1	87	83	88*	82
	D/H	2	90	86	91*	85*
Speaker Visible	A/E	1/4	79	76	81	78
	B/F	1/2	83	80	84	81
	C/G	1	86	82	88*	84
	D/H	2	89	86	90*	87*

- NOTES:**
- Reverberant dBA measurements are a minimum UL rating based on sound level measurements made in UL's reverberant test chamber.
 - Anechoic dBA measurements are a minimum ULC rating based on sound pressure level measurements made in ULC's anechoic test chamber.
 - The sound pressure level decreases by 3 dB at an angular displacement of 75° from the line perpendicular to the speaker's center. The SPL decreases by 6 dB at an angle of 85° from that line.
- * Only marked settings may be used for ULC fire alarm applications.